

NAPOLEON

WOOD BURNING FIREPLACES



WOOD BURNING FIREPLACES
napoleon.com



Add an element of “home” to your house with a Napoleon Wood Burning Fireplace.

High Country™ 3000 ECO.....	4 - 5
High Country™ 5000.....	6 - 7
High Country™ 6000.....	8 - 9
High Country™ 8000.....	10 - 11
Outstanding Features.....	12
Options, Features & Accessories.....	12
Anatomy of the Perfect Fireplace.....	13
Specs, Options, Features & Accessories.....	14 - 15



The High Country™ 5000 shown with Smooth Decorative Brick Panels.



FIND YOUR HAPPY (fire)PLACE.

Throughout the ages, people have gathered around fires to share in life's greatest joys.

There's just something about the glow of flickering flames that makes special moments feel even warmer.

A Napoleon fireplace is uniquely designed to brighten the vibe of any room in your house. Napoleon has an incredible range of designer options to fit any vision.

A fire not only raises the warmth and ambiance of a room, it can raise the value of your home. A fireplace offers some of the highest returns of any remodeling project. And that should make you feel good all over.

Every Napoleon fireplace is backed by the President's Limited Lifetime Warranty to ensure you can keep enjoying that positive glow for years and years and years to come.

High Country™ 3000 Eco

Wood Burning Elegance



Napoleon's High Country™ 3000 Eco wood burning fireplace is the smaller version of the powerful High Country™ 6000. The High Country™ 3000 Eco has a catalytic combustor, yes, just like your car. This fireplace has been 2020 EPA certified and achieves lowest emissions possible while still maintaining heat. Four stainless steel secondary air tubes supercharge the fuel burning process and generates a fascinating display of **YELLOW DANCING FLAMES**™.

NZ3000H-1

Glass Door Viewing Area: 17" h x 27 3/8" w

Feature Points

- Catalytic Converter
- Digital Catalyst Temperature Monitor
- President's Limited Lifetime Warranty
- Advanced Airwash system
- Cast iron bypass door and baffle

For more detailed specifications on this unit, see page 14

Features & Accessories



Napoleon Handle

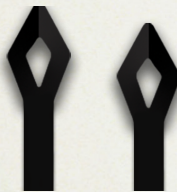

Steel Andirons in Charcoal Finish



Optional Heat Resistant Gloves



Complete Arched Wrought Iron Double Doors, Faceplate, Grill & Keystone



Arched Faceplate & Modern Inset in Painted Black Finish with Painted Black Cast Iron Double Doors



Arched Faceplate & Heritage Inset in Painted Black Finish with Painted Black Cast Iron Double Doors





The High Country[™] 3000 Eco shown with arched faceplate with modern insets and black cast iron double doors.

High Country™ 5000

Wood Burning Elegance



Napoleon's High Country™ 5000 Wood Burning Fireplace is perfect for adding the impact of a European-inspired, clean face design, with the traditional look and feel of an old-world fireplace. Built-in horizontal and vertical air flow directional ridges supercharge the air below and behind the wood creating extremely fast start-ups and direct the smoke up and to the back of the firebox for the ultimate clean burning experience. The counterbalanced, ZERO GRAVITY™ screen and door operate with ease, making lighting, and loading of this fireplace effortless. Bask in the glow of a wood fire that will add impact and luxury to your favorite space.

NZ5000-T

Glass Door Viewing Area: 20 7/16"h x 30 1/2"w

For more detailed specifications on this unit, see page 14

Features & Accessories

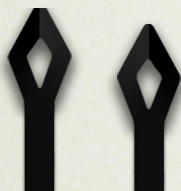

Steel Andirons in Charcoal Finish



Heat Resistant Gloves (included)



Smooth and Traditional Decorative Brick Panels



Door Handle (included)



Shown with Glass Door Down and Smooth Decorative Brick Panels



Shown with Screen Door Down and Smooth Decorative Brick Panels



Shown with Glass Door Down and Traditional Decorative Brick Panels

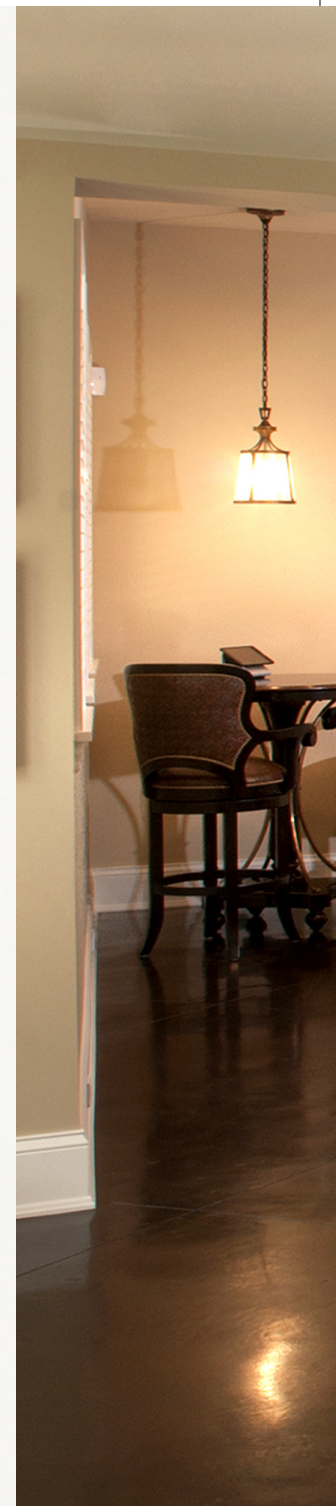



The High Country™ 5000 shown with Smooth Decorative Brick Panels.

High Country™ 6000

A Showcase For Your Home



The perfect blend of elegant, rustic styling and state-of-the-art wood burning technology makes this luxurious fireplace an ideal choice to add class and artistry to your home. The High Country™ 6000 stands out in the crowd and is well deserving of the Napoleon insignia. Treasured for its quality and performance, every Napoleon fireplace is hand crafted to last for generations.



Complete Arched Wrought Iron Double Doors, Faceplate, Grill & Keystone

NZ6000-1

Glass Door Viewing Area: 20 3/8" h x 34 3/4" w

For more detailed specifications on this unit, see page 15



Shown Complete with Arched Black Cast Iron Double Doors, Arched Faceplate, Grill & Keystone in Painted Black Finish

Features & Accessories



Andirons Painted Black Finish



Optional Arched Screen Kit Painted Black Finish



Optional Country Crane & Hearth Pot



Optional Heat Resistant Gloves

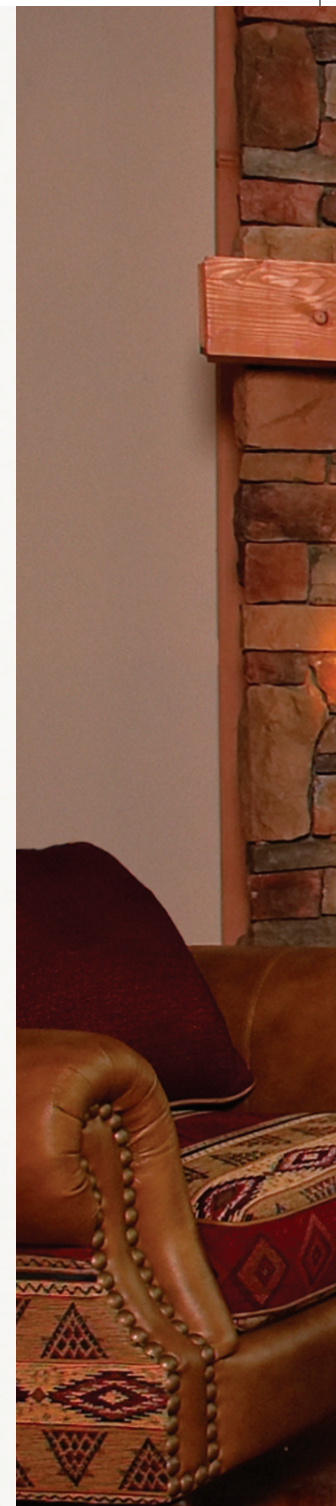



The High Country™ 6000 shown with wrought iron finish double doors, faceplate, upper grill and keystone

High Country™ 8000

Warming Homes & Hearts



The Napoleon High Country™ 8000 is a large, clean face wood burning fireplace with an exceptionally wide viewing area. The exclusive counterbalanced ZERO GRAVITY™ door system operates the screen and heat radiating ceramic glass independently. This allows the fire to be viewed through either the glass, screen or both as they glide effortlessly up behind the wall. Boasting a large firebox that is lined with custom molded refractory brick, the High Country™ 8000 can hold up to 50 lbs of wood.

NZ8000

Glass Door Viewing Area: 26 9/16"h x 39 13/16"w

For more detailed specifications on this unit, see page 15



Shown with Smooth Decorative Brick Panels



Shown with Traditional Decorative Brick Panels



Shown with Herringbone Decorative Brick Panels

Features & Accessories

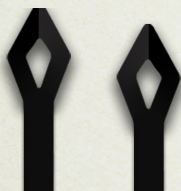

Steel Andirons in Charcoal Finish



Heat Resistant Gloves



Smooth Decorative Brick Panels



Traditional Decorative Brick Panels



Herringbone Decorative Brick Panels





The High Country® 8000 shown with Traditional Decorative Brick Panels.

Outstanding Features

of Napoleon's Advanced Technology

Help Protect The Environment With A Napoleon Wood Burning Fireplace

Heating your home with a Napoleon high efficiency fireplace, stove or insert releases no more carbon dioxide than a dying tree would lying on the forest floor. In fact, when the entire carbon cycle is considered, a Napoleon fireplace heats your home more efficiently and with less impact on the environment than any other heating fuel option.

Outstanding Craftsmanship

Fine details are designed in every aspect of Napoleon fireplaces... individually handcrafted with pride of excellence.

WHISPER QUIET™ Heat Circulating Blower System

The extreme heat resistant "H" class bearings featured in Napoleon's superior heat circulating blower, creates a lasting "whole home" comfort with adjustable high & low speeds. Available on the NZ3000H-1 and NZ6000-1 only.

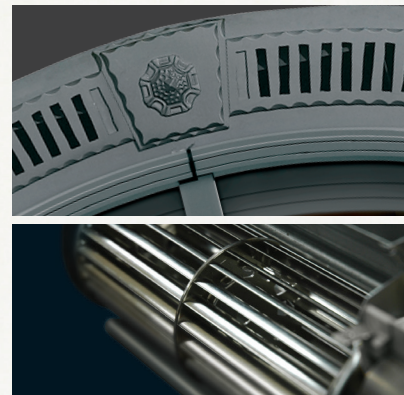
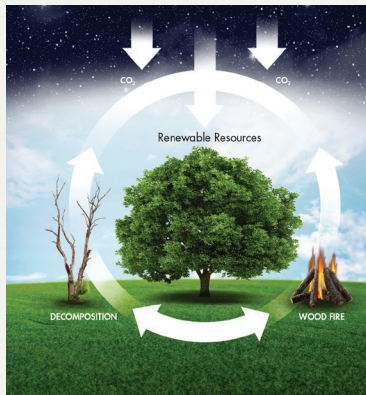

ZERO GRAVITY™ Door System

The ZERO GRAVITY™ door system found on the 5000 and 8000 models, boast glass and screen doors that have precision 4-way roller systems that have been proven and tested to 60 years of operation. The door system also allows glass and screen doors to operate independently and glide up behind the wall.

Features, Options & Accessories

Decorative Brick Options

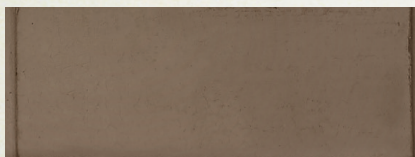

Smooth Decorative Brick Panels
(NZ5000 and NZ8000 Models Only)

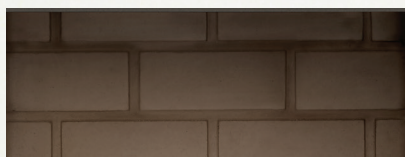

Traditional Decorative Brick Panels
(NZ5000 and NZ8000 Models Only)

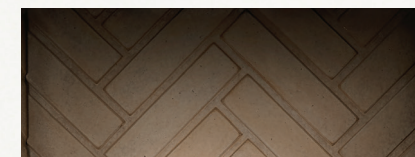

Herringbone Decorative Brick Panels
(NZ8000 Model Only)

Accessories



Steel Andirons Charcoal Finish
(Excluding NZ6000 Model)



Andirons Painted Black Finish
(NZ6000 Model Only)



Heat Resistant Gloves



Decorative Handle



Country Crane & Hearth Pot
(NZ6000 Model Only)

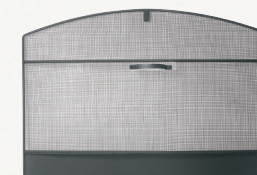

Arched Screen Kit Painted Black Finish
(NZ6000 Model Only)



High Country™ 3000 Eco

Anatomy of the Perfect Fireplace

1. Primary combustion air is brought into the unit through the fresh air intake collar located on the bottom side of the unit.
2. Catalytic combustor increases efficiency, decreases emissions and provides longer burn times.
3. Combustion takes place inside the firebox where smoke and gases are directed around a large baffle and through a catalyst (similar to the technology in a car) which burns off harmful gasses. As these gasses burn, the catalyst radiates more heat into the room providing maximum efficiency.
4. The optional hot air gravity central heating vent system may be used to distribute heat to an adjoining room (located either above or beside the room containing the fireplace).
5. The optional blower provides an ideal means of circulating warm air within the home. Where location permits and extreme cold temperatures are not experienced, this blower may also be installed to utilize fresh outside air to introduce "positive pressure" to the home. The powerful 320 CFM blower can be installed remotely from the unit (ie. basement) so you can enjoy increased air circulation with WHISPER QUIET operation.
6. Radiant Heat.
7. A single air control regulates the burn rate.
8. High Heat Ceramic Glass for added durability.
9. Primary air is directed down along the glass before being combusted to help keep the glass clean.
10. Fully insulated outershell to reduce clearances.
11. Pre-heated secondary combustion air is injected into the top of the fire box to help combust any un-burnt fuel gasses before they reach the catalyst. This provides both a dazzling blanket of fire and extracts the maximum amount of heat per fuel load.
12. Cast iron baffle and bypass door are durable and allow for easy start up and refueling.
13. Cool Room air circulates around the firebox and is pushed back into the room for additional heat.

Approved with chimneys

Any 7" diameter chimney listed to these standards may be installed. In accordance with these standards, the unit may also be connected to any chimney listed to CAN/ULC-S604 and CAN/ULC-S629 for Canada or UL-103HT for the United States.

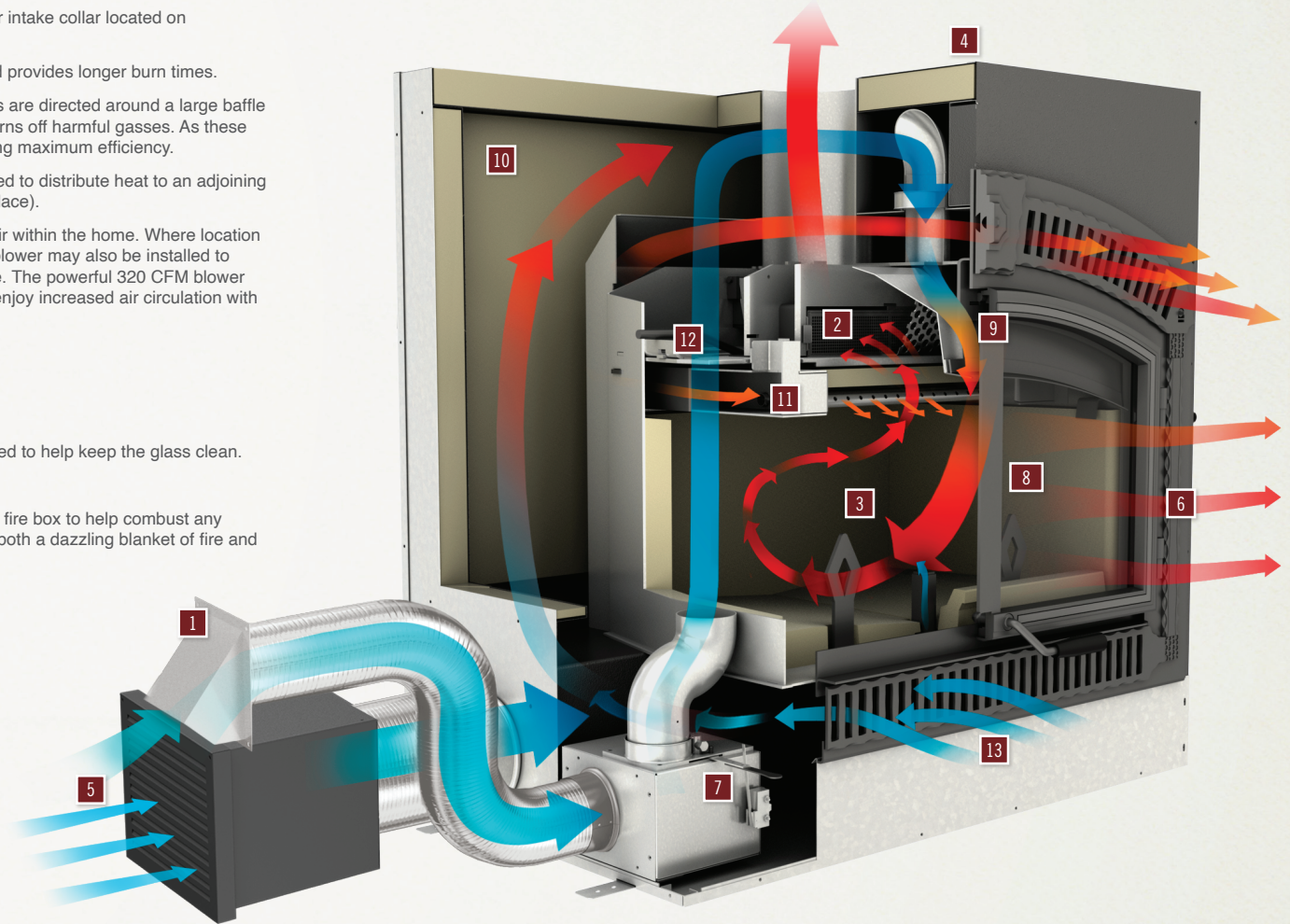

Minimum Clearance to combustibles

Minimum, fireplace	0" to stand offs (rear) 6" to sides
Ceiling enclosure	84" from the base of the unit
Ceiling (in front of fireplace)	84" from the base of the unit
Chimney	2" (follow manufacturer's instructions)
Hot air gravity duct work	1"
Mantle to top of faceplate	from 12" (with mantel protruding 2") to 18" (with mantel protruding 8")
Minimum hearth extension	20" x 54" non-combustible surface

Hot Air Venting Options

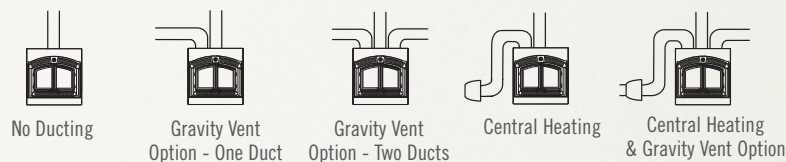

High Country™ 3000 Eco

Shown on pages 4 & 5

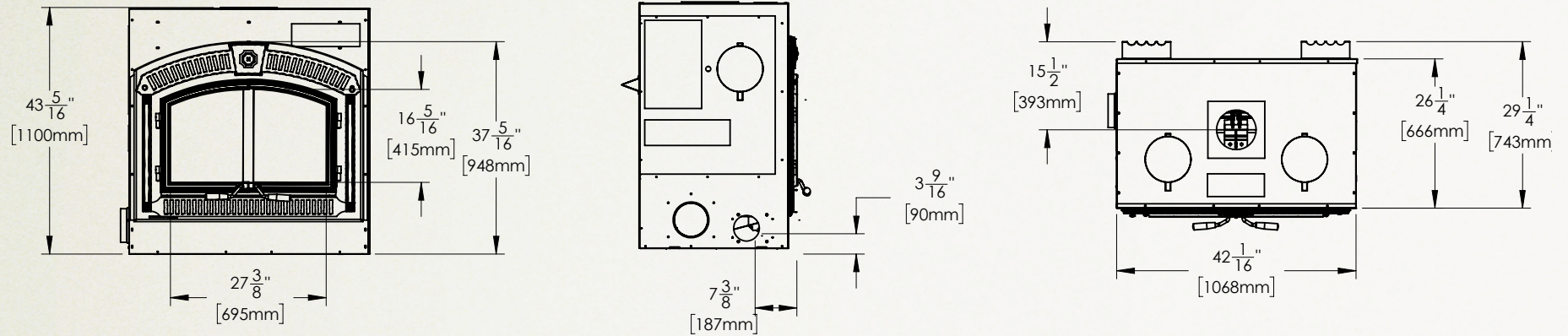

High Country™ 5000

Shown on pages 6 & 7

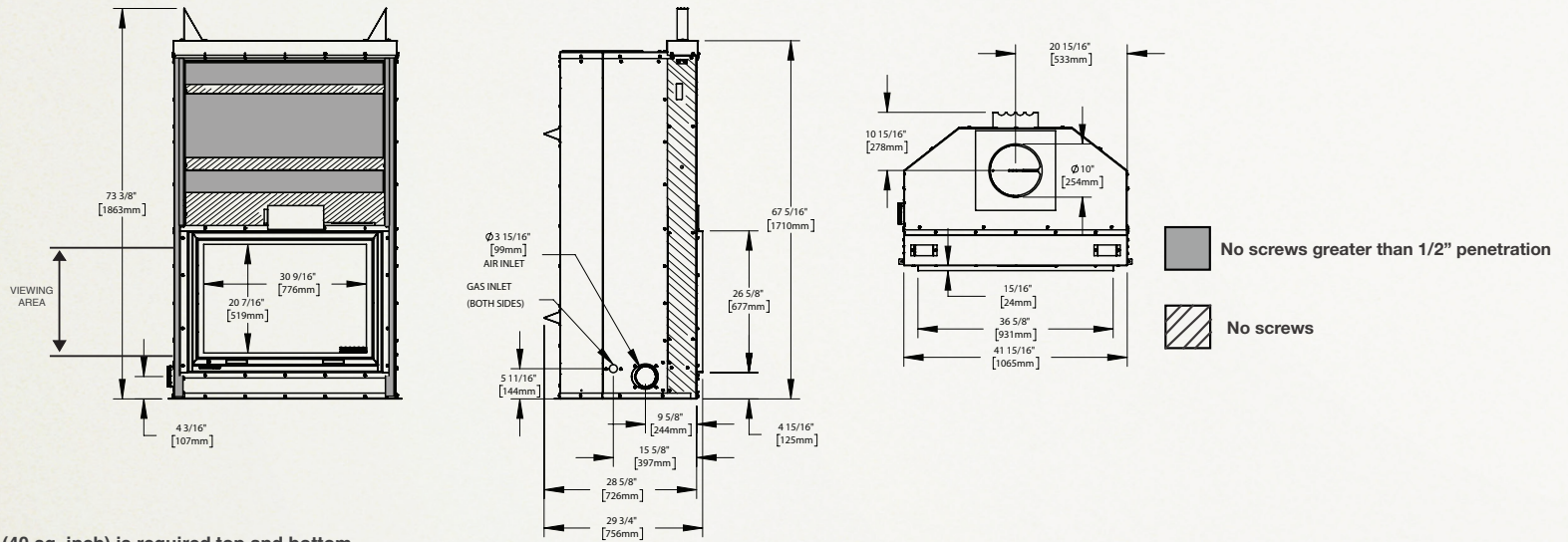

NOTE: A ventilated enclosure (40 sq. inch) is required top and bottom.

Model	Firebox Size (cu. ft.)	Area Heated (sq. ft.)	Emissions (Grams Per Hour)	Log Size (Max)	Chimney Diameter	Outside Air for Combustion	EPA Certified	Mobile Home Approved	Central Heating and/or Blower	Door Opening		Viewing Area		Viewing Area (sq.inch)	Weight of Bricks	Weight without Bricks
										Width	Height	Width	Height			
NZ3000H-1*	2.3	2000 +	1.38	25"	7"	Yes	Yes	No	Optional	40"	31 11/16"	27 3/8"	17"	391	103 lbs	448 lbs
NZ5000**	6.6	1000	4.6	24"	8"	Yes	Yes	No	N/A	36 5/8"	26 5/8"	30 1/2"	20 7/16"	623	193 lbs	552 lbs

*Tested and listed by Services Polytests inc. as per EPA METHODS ALT-125, ASTM, E2515, ASTM E3053 and CSA B415.1 for CATALYTIC WOOD HEATER FOR EMISSIONS AND EFFICIENCY to US EPA's cord wood emissions standards for 2020 (EPA 40 CFR Part 60 Subpart AAA). CERTIFIED TO COMPLY WITH 2020 PARTICULATE EMISSIONS STANDARDS.

Figures may vary with individual conditions such as floor plan layout, insulation value of the home and the firewood used. Rated BTU/h with softwood test fuel (for emissions only) - no refueling. Wolf Steel Ltd. own test results showing realistic BTU's using hardwood logs with regular refueling. Heat output will differ on chimney draft as well as type, moisture content and size of wood.

High Country™ 6000

Shown on pages 8 & 9

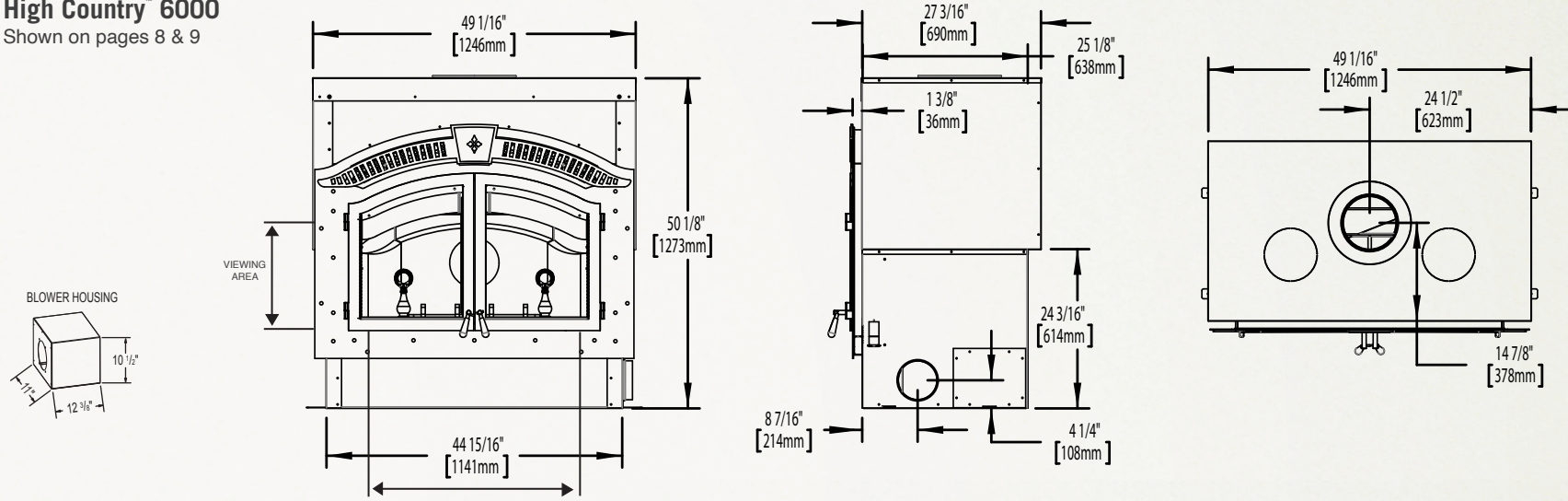

High Country™ 8000

Shown on pages 12 & 13

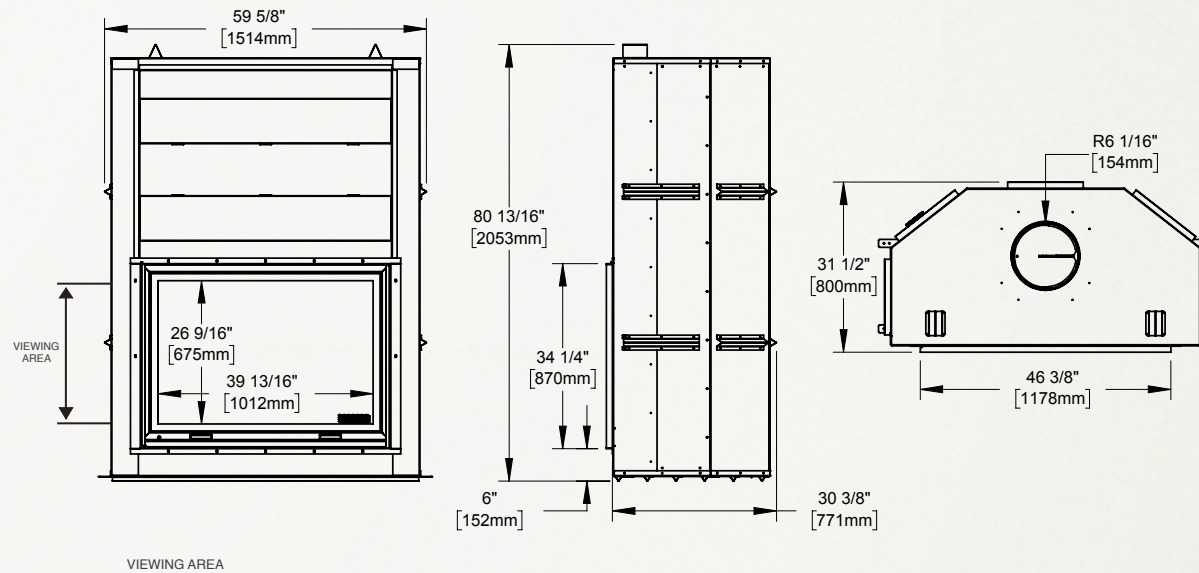

VIEWING AREA

Model	Firebox Size (cu. ft.)	Area Heated (sq. ft.)	Emissions (Grams Per Hour)	Log Size (Max)	Chimney Diameter	Outside Air for Combustion	EPA Qualified	Mobile Home Approved	Central Heating and/or Blower	Door Opening		Viewing Area		Viewing Area (sq.inch)	Weight of Bricks	Weight without Bricks
										Width	Height	Width	Height			
NZ6000-1**	4.8	3000 +	N/A	32"	8"	Yes	N/A	No	Optional	48 1/2"	26 5/8"	34 3/4"	16 5/8"	708	110 lbs	583 lbs
NZ8000**	9.65	1000	2.2	32"	10"	Yes	Yes	No	No	46 3/8"	34 1/4"	22"	28 1/2"	1057	300 lbs	1150 lbs

*Tested and listed by Services Polytests inc. as per EPA METHODS ALT-125, ASTM, E2515, ASTM E3053 and CSA B415.1 for CATALYTIC WOOD HEATER FOR EMISSIONS AND EFFICIENCY to US EPA's cord wood emissions standards for 2020 (EPA 40 CFR Part 60 Subpart AAA). CERTIFIED TO COMPLY WITH 2020 PARTICULATE EMISSIONS STANDARDS.

Figures may vary with individual conditions such as floor plan layout, insulation value of the home and the firewood used. Rated BTU/h with softwood test fuel (for emissions only) - no refueling. Wolf Steel Ltd. own test results showing realistic BTU's using hardwood logs with regular refueling. Heat output will differ on chimney draft as well as type, moisture content and size of wood.

NAPOLEON

CELEBRATING OVER 40 YEARS OF HOME COMFORT PRODUCTS



24 Napoleon Road, Barrie, Ontario, Canada L4M 0G8
 103 Miller Drive, Crittenden, Kentucky, USA 41030
 7200 Trans Canada Highway, Montreal, Quebec, Canada H4T 1A3

Tel: 1-888-721-7253
napoleon.com



Authorized Dealer

Consult your owner's manual for complete installation instructions and proper clearances to combustibles. Check all local and national building codes and regulations. All specifications are subject to change without prior notice due to on-going product improvements. Products may not be exactly as shown. Heat output will vary based on fuel type, quality and moisture content. Napoleon is a registered trademark of Wolf Steel Ltd. © Wolf Steel Ltd.

Printed in Canada
 ADBR840 - 02/2021