



GAS FIREPLACE INSERTS

REGENCY-FIRE.COM



WHY CHOOSE REGENCY?

At Regency, our past 40 years have been focused on providing a high-level of service while building high-quality and reliable products that our customers can enjoy for years to come.

HIGH-QUALITY

Producing a high-quality product has been at the very heart of what we do from when that very first stove rolled off the production line over 40 years ago to today. We are ever-focused on producing quality products for our customers that will last for years to come.

BEST WARRANTY

A fireplace should be reliable and should work right the first time it is used, and the 1,000th. A core part of our business is making sure that we are building long-lasting, durable, high-quality products; we back-up that commitment with the industry's best warranty on all our products.

COST-EFFICIENT

Never before have home heating costs been higher. Turn your furnace way down and zone heat with our beautiful, reliable and convenient Regency products. Not only can you cut your fuel bills in half, but you'll be able to enjoy the timeless comfort of a Regency fire.

Why Regency? Because it's more than a fireplace!



TABLE OF CONTENTS

Regency Liberty® Radiant Gas Inserts	
Regency Horizon® Radiant Gas Inserts	
LRI3E	04
HRI3E	06
LRI4E	08
HRI4E	10
LRI6E	12
HRI6E	14

Regency Energy™ Gas Inserts	
Regency Liberty® Gas Inserts	
E33	16
E21, U31	18
L234	20

Backing Plates, Faceplates & Inlays	22
-------------------------------------	-----------

Accessories	25
-------------	-----------

Specifications	28
----------------	-----------





LRI3E shown with Vignette faceplate in Black and Old Town Red interior panels.

REGENCY LIBERTY® RADIANT

LRI3E Compact Gas Insert



LRI3E shown with small backing plate and Vignette faceplate in Platinum



LRI3E shown with regular backing plate and Vignette faceplate in Tuscan Sunset



LRI3E shown with arched backing plate and arched Vignette faceplate in black

COMPACT AND EFFICIENT

Regency is proud to present the newest addition to the Liberty gas insert family, now available in a smaller size to fit a larger array of spaces. Enjoy timeless, artisan crafted logs with the combined power of radiant & convective heat. Vignette designer faceplates provide you with the choice to create a modern transitional look or a traditional look with Georgian & Tudor styles.

SPECIFICATIONS (NATURAL GAS)*

Input (BTU)	20,500
Turn down to (BTU)	14,000
Efficiency (steady state)	73.12%
EnerGuide Rating (Canada only)	66.25%

MINIMUM FIREPLACE OPENING

Width (front)	28-1/2"
Width (rear)	21-5/8"
Height	19-1/2"
Depth	14-1/2"

*For propane (LP) specs please see page 28.



LRI3E shown with 4-sided regular backing plate and Vignette faceplate in Platinum.



LRI3E shown with regular backing plate, Vignette faceplate in Black, Craftsman inlay in Black Chrome



LRI3E shown with regular backing plate, Vignette faceplate in Black, Door inlay in Tuscan Sunset



LRI3E shown with regular backing plate, Vignette Georgian faceplate in Black

FEATURES

- Natural gas
- Safety screen with ceramic safety glass
- High definition 7 piece log set with ceramic burner and glowing ember bed
- Proflame II GTMF remote control system
- Variable speed blower for max heat distribution
- 30° angled flue for versatile installation
- Direct vent
- Limited lifetime warranty

OPTIONS

- Vignette faceplates in various designs and colors
- Vignette inlays in various designs and colors
- Interior panels in Old Town Red, Rustic Brown or Volcanic Black
- Reflective black enamel interior panels
- Small, regular, arched, oversized and custom backing plates
- Hearth trim kit and mantel deflector
- Regency flex liners
- Propane conversion kit



HRI3E shown with Vignette faceplate in Black, Black Crystals with Volcanic Stones and Black Reflective Enamel panels.

REGENCY HORIZON® RADIANT

HRI3E Compact Gas Insert



HRI3E shown with small backing plate, Vignette faceplate in Black Chrome with Starfire Crystals



HRI3E shown with arched backing plate and arched Vignette faceplate in black with optional volcanic stones



HRI3E shown with 4-sided regular backing plate, Vignette faceplate in Black Chrome with Black Crystals

COMPACT AND CUSTOMIZABLE

Designed for contemporary spaces, the HRI3E is the newest addition to the Regency Horizon family of gas inserts. The HRI3E gas insert delivers heat efficiently and with captivating style. Choose the look you want with a fine selection of accent options. Colored glass crystals or firebeads combine elegantly with spa stones or driftwood logs.

SPECIFICATIONS (NATURAL GAS)*

Input (BTU)	19,500
Turn down to (BTU)	14,000
Efficiency (steady state)	71.73%
EnerGuide Rating (Canada only)	64.36%

MINIMUM FIREPLACE OPENING

Width (front)	28-1/2"
Width (rear)	21-5/8"
Height	19-1/2"
Depth	14-1/2"

*For propane (LP) specs please see page 28.



HRI3E shown with regular backing plate, Vignette faceplate in Platinum with Black Crystals and optional Driftwood log set.



HRI3E shown with regular backing plate, Vignette faceplate in Black, Craftsman inlay in Black Chrome with Black Crystals and optional Driftwood log set



HRI3E shown with regular backing plate, Vignette faceplate in Black, Door inlay in Tuscan Sunset with Black Crystals and optional Volcanic Stones



HRI3E shown with regular backing plate, Vignette Tudor faceplate in Black with Black Crystals and optional Volcanic Stones

FEATURES

- Natural gas
- Safety screen with ceramic safety glass
- Regency Horizon contemporary linear fire bed with black steel interior panels
- Proflame II GTMF remote control system
- Variable speed blower for max heat distribution
- 30° angled flue for versatile installation
- Direct vent
- Limited lifetime warranty

OPTIONS

- Vignette faceplates in various designs and colors
- Vignette inlays in various designs and colors
- Firebeads and crystals in various colors
- Driftwood log set, Volcanic Stones, Spa Stones or River Pebbles
- Reflective black enamel interior panels
- Small, regular, arched, oversized and custom backing plates
- Hearth trim kit and mantel deflector
- Regency flex liners
- Propane conversion kit



LRI4E shown with regular backing plate, Vignette faceplate in Black, Door Inlay in Black and Rustic Brown Brick Panels.

REGENCY LIBERTY® RADIANT | LRI4E Medium Gas Insert



LRI4E shown with small backing plate and Vignette faceplate in Platinum



LRI4E shown with regular backing plate and Vignette faceplate in Tuscan Sunset



LRI4E shown with 4-sided regular backing plate and Vignette faceplate in Black

PERFORMANCE AND STYLE

The Liberty Radiant LRI4E gas insert exemplifies Regency's renowned commitment to quality. A source of both radiant and convective heat, the LRI4E delivers high efficiency heat safely and reliably throughout your home. Turn on the integrated circulating fan to intensify the warming effect. This statement fireplace can be customized with Regency's fine selection of accent trim options.

NOTE: Fireplace opening sizes may differ depending on option chosen and type of masonry fireplace. See product specifications on page 29.

SPECIFICATIONS (NATURAL GAS)*

Input (BTU)	31,000
Turn down to (BTU)	22,000
Efficiency (steady state)	71.45%
EnerGuide Rating (Canada only)	70.27%

MINIMUM FIREPLACE OPENING (VIGNETTE FACEPLATE)

Width (front)	30"
Width (rear)	22"
Height	20"
Depth (without spacer)	18"
Depth (with spacer)	15-3/4"

*For propane (LP) specs please see page 28.



LRI4E shown with arched backing plate and decorative arched Vignette faceplate in black.



LRI4E shown with regular backing plate, Vignette faceplate in Black, Craftsman inlay in Black Chrome



LRI4E shown with regular backing plate, Vignette faceplate in Black and Door inlay in Tuscan Sunset



LRI4E shown with regular backing plate and Vignette Georgian faceplate in Black

FEATURES

- Natural gas
- Safety screen
- Ceramic safety glass
- High definition log set
- Ceramic burner with glowing ember bed
- Electronic ignition with SureFire™ switch
- Proflame I GTMF remote control
- Variable speed blower for max heat distribution
- 6-tube heat exchanger for max efficiencies
- 30° angled flue for versatile installation
- Direct vent
- Limited lifetime warranty

OPTIONS

- Vignette faceplates in various designs and colors
- Vignette inlays in various designs & colors
- Faceplate spacer for shallow fireplace installations
- Interior panels in Old Town Red, Rustic Brown or Volcanic Black
- Reflective Black Enamel Interior Panels
- Small, regular, arched, oversized and custom backing plates
- Mantel deflector for reduced clearances
- Hearth trim kits for raised hearth installations
- Wall thermostat
- Regency flex liners
- Propane conversion kit



HRI4E shown with 4-sided regular backing plate, Vignette faceplate in Platinum with Black Crystals and optional Driftwood log set.

REGENCY HORIZON® RADIANT | HRI4E Medium Gas Insert



HRI4E shown with small backing plate and Vignette faceplate in black with Black Crystals and optional Driftwood log set



HRI4E shown with arched backing plate, arched Vignette faceplate in black with optional white crystals



HRI4E shown with 4-sided regular backing plate and Vignette faceplate in Black with optional black crystals

MODERN AND ELEGANT

Add comfort and update the look of your home with a Regency Horizon Radiant medium sized gas insert. Radiant inserts deliver heat efficiently and can be customized with captivating firebed options. Simply choose the style you want: combine colored glass crystals or firebeads with spa stones for natural elegance or select driftwood logs for coastal look.

NOTE: Fireplace opening sizes may differ depending on option chosen and type of masonry fireplace. See product specifications on page 29.

SPECIFICATIONS (NATURAL GAS)*

Input (BTU)	31,000
Turn down to (BTU)	22,000
Efficiency (steady state)	71.45%
EnerGuide Rating (Canada only)	70.27%

MINIMUM FIREPLACE OPENING (VIGNETTE FACEPLATE)

Width (front)	30"
Width (rear)	22"
Height	20"
Depth (without spacer)	18"
Depth (with spacer)	15-3/4"

*For propane (LP) specs please see page 28.



HRI4E shown with regular backing plate, Vignette faceplate in Platinum and Black Crystals.



HRI4E shown with regular backing plate, Vignette faceplate in Black, Craftsman inlay in Black Chrome with Black Crystals and optional Volcanic Stones



HRI4E shown with regular backing plate, Vignette faceplate in Black and Door inlay in Tuscan Sunset with Black Crystals



HRI4E shown with regular backing plate and Vignette Tudor faceplate in Iron Grey with Black Crystals

FEATURES

- Natural gas
- Safety screen
- Ceramic safety glass
- Ceramic burner with glowing ember bed
- Electronic ignition with SureFire™ switch
- Proflame I GTMF remote control
- Variable speed blower for max heat distribution
- 6-tube heat exchanger for max efficiencies
- 30° angled flue for versatile installation
- Direct vent
- Limited lifetime warranty

OPTIONS

- Vignette faceplates in various designs and colors
- Vignette inlays in various designs & colors
- Faceplate spacer for shallow fireplace installations
- Crystals or firebeads in various colors
- Volcanic Stones, Spa Stones, or accent River Pebbles
- Driftwood log set
- Reflective black enamel interior panels
- Small, regular, arched, oversized and custom backing plates
- Mantel deflector for reduced clearances
- Hearth trim kits for raised hearth installations
- Wall thermostat
- Regency flex liners
- Propane conversion kit



LRI6E shown with regular backing plate, Vignette faceplate in black, craftsman inlay in tuscan sunset.

REGENCY LIBERTY® RADIANT

LRI6E Large Gas Insert



LRI6E shown with small backing plate and Vignette faceplate in Tuscan Sunset



LRI6E shown with regular backing plate and Vignette faceplate in Black



LRI6E shown with 4-sided regular backing plate and Vignette faceplate in Platinum

RADIANT CONVECTIVE HEAT

This large, high efficiency heater provides intense radiant heat instantly. Enjoy strong heat in the area directly in front of your fireplace or turn on the included heat circulating blower to distribute comforting warmth into the far corners of your room. The Regency Liberty LRI6E large gas insert is a stylish, reliable source of warmth and ambience, even during a power outage.

NOTE: Fireplace opening sizes may differ depending on option chosen and type of masonry fireplace. See product specifications on page 29.

SPECIFICATIONS (NATURAL GAS)*

Input (BTU)	38,000
Turn down to (BTU)	25,000
Efficiency (steady state)	73.01%
EnerGuide Rating (Canada only)	70.37%

MINIMUM FIREPLACE OPENING (VIGNETTE FACEPLATE)

Width (front)	34"
Width (rear)	25"
Height	24"
Depth (without spacer)	19-1/2"
Depth (with spacer)	16-3/4"

*For propane (LP) specs please see page 28.



LRI6E shown with arched backing plate and arched decorative vignette in black.



LRI6E shown with regular backing plate, Vignette faceplate in Black, Door inlay in Black Chrome



LRI6E shown with regular backing plate, Vignette Tudor faceplate in Iron Grey, Door inlay in Black Chrome



LRI6E shown with regular backing plate, Vignette faceplate in Black, Door inlay in Tuscan Sunset

FEATURES

- Natural gas
- Safety screen
- Ceramic safety glass
- High definition log set
- Ceramic burner with glowing ember bed
- Black steel interior panels
- Electronic ignition with SureFire™ switch
- Proflame I GTMF remote control
- Variable speed blower for max heat distribution
- 6-tube heat exchanger for max efficiencies
- 30° angled flue for versatile installation
- Direct vent
- Limited lifetime warranty

OPTIONS

- Vignette faceplates in various designs and colors
- Vignette inlays in various designs & colors
- Faceplate spacer for shallow fireplace installations
- Interior panels in Old Town Red, Rustic Brown or Volcanic Black
- Reflective black enamel interior panels
- Small, regular, arched, oversized and custom backing plates
- Mantel deflector for reduced clearances
- Hearth trim kits for raised hearth installations
- Wall thermostat
- Regency flex liners
- Propane conversion kit



HRI6E shown with regular backing plate, Vignette faceplate in Black Chrome with Black Crystals and optional Driftwood log set.

REGENCY HORIZON® RADIANT | HRI6E Large Gas Insert



HRI6E shown with small backing plate, Vignette faceplate in Platinum with Black Crystals and optional Volcanic Stones



HRI6E shown with arched backing plate, arched Vignette faceplate in black with Black Crystals and optional Driftwood log set



HRI6E shown with 4-sided regular backing plate, Vignette faceplate in Black Chrome with Black Crystals

SLEEK AND CONTEMPORARY

The Regency Horizon Radiant Series introduces a sleek, contemporary large gas insert designed to transform your existing fireplace. Choose from a fine selection of modern Vignette faceplates and firebed options to create a unique look. Backed by the industry's best warranty, the HRI6E provides reliable, high efficiency heat with exceptional styling.

NOTE: Fireplace opening sizes may differ depending on option chosen and type of masonry fireplace. See product specifications on page 29.

SPECIFICATIONS (NATURAL GAS)*

Input (BTU)	38,000
Turn down to (BTU)	25,000
Efficiency (steady state)	73.01%
EnerGuide Rating (Canada only)	70.37%

MINIMUM FIREPLACE OPENING (VIGNETTE FACEPLATE)

Width (front)	34"
Width (rear)	25"
Height	24"
Depth (without spacer)	19-1/2"
Depth (with spacer)	16-3/4"

*For propane (LP) specs please see page 28.



HRI6E shown with regular backing plate, Vignette faceplate in Black Chrome, Black Crystals with Volcanic Stones and Black Reflective Enamel panels.



HRI6E shown with regular backing plate, Vignette faceplate in Black, Door inlay in Black Chrome with Starfire Crystals



HRI6E shown with regular backing plate, Vignette faceplate in Black, Craftsman inlay in Black Chrome with Black Crystals



HRI6E shown with regular backing plate, Vignette Tudor faceplate in Black with Black Crystals and optional Volcanic Stones

FEATURES

- Natural gas
- Safety screen
- Ceramic safety glass
- Ceramic burner with glowing ember bed
- Black steel interior panels
- Electronic ignition with SureFire™ switch
- Proflame I GTMF remote control
- Variable speed blower for max heat distribution
- 6-tube heat exchanger for max efficiencies
- 30° angled flue for versatile installation
- Direct vent
- Limited lifetime warranty

OPTIONS

- Vignette faceplates in various designs and colors
- Vignette inlays in various designs & colors
- Faceplate spacer for shallow fireplace installations
- Crystals or firebeads in various colors
- Volcanic Stones, Spa Stones, or accent River Pebbles
- Driftwood log set
- Reflective black enamel interior panels
- Small, regular, arched, oversized and custom backing plates
- Mantel deflector for reduced clearances
- Hearth trim kits for raised hearth installations
- Wall thermostat
- Regency flex liners
- Propane conversion kit



E33 shown with Low Profile faceplate and Brick panels.

REGENCY ENERGY™

E33 Large Gas Insert

AN ATTRACTIVE HEAT SOURCE

With 38,000 BTU of comforting, controllable heat and a full, elegant flame, this large insert is guaranteed to warm your room and your heart. This direct vent gas insert is perfect for airtight homes or basements because the sealed firebox doesn't use internal air. All Regency gas inserts can be enjoyed from the comfort of your sofa with the Proflame remote control or wall thermostat.

SPECIFICATIONS (NATURAL GAS)*

Input (BTU)	38,000
Turn down to (BTU)	20,000
Efficiency (steady state)	70.14%
EnerGuide Rating (Canada only)	60.70%

MINIMUM FIREPLACE OPENING

Width (front)	32-1/4"
Width (rear)	25"
Height	24-3/16"
Depth (without spacer)	18"
Depth (with spacer)	16-3/4"

*For propane (LP) specs please see page 28.



E33 Shown with Vignette faceplate in Black, Door inlay in Tuscan Sunset and Brick panels.



E33 shown with Vignette faceplate in Black



E33 shown with Vignette faceplate in Black and Door inlay in Black Chrome



E33 shown with Vignette faceplate in Black and Door inlay in Black

FEATURES

- Natural gas
- Safety screen
- Ceramic safety glass
- Proflame I GTM remote control
- Log set with glowing embers
- Flame height adjustment control
- Variable speed blower
- 30° angled flue for versatile installations
- Standing pilot system
- Direct spark ignition
- Limited lifetime warranty

OPTIONS

- Faceplates in low profile or Vignette design
- Vignette door inlay in various colors
- Custom backing plate
- Brick panels
- Wall thermostat
- Installation spacer
- Regency flex liners
- Propane conversion kit



U31 shown with Low Profile faceplate and Brick panels.

REGENCY ENERGY™ | U31 Medium Gas Insert

CUSTOMIZE TO SUIT YOUR STYLE

These Regency inserts are a complete fireplace system that can turn your existing wood fireplace into a high efficiency, clean burning gas heater. Enjoy peace of mind even during power outages; all Regency gas inserts operate safely and effectively without electricity. Stay warm, no matter what!

SPECIFICATIONS (NATURAL GAS)*	U31	E21
Input (BTU)	30,000	23,500
Turn down to (BTU)	20,600	11,750
Efficiency (steady state)	58.45%	61.63%
EnerGuide Rating (Canada only)	51.42%	49.29%

MINIMUM FIREPLACE OPENING		
Width (front)	26-1/2"	26-1/2"
Width (rear)	22-1/2"	18"
Height	21"	17-3/4"
Depth (without spacer)	--	13-1/8"
Depth (with spacer)	15"	14-3/8"

*For propane (LP) specs please see page 28.



E21 shown with Low Profile faceplate and Brick panels.

REGENCY ENERGY™

E21 Small Gas Insert

FEATURES

- Natural gas
- Safety screen
- Ceramic safety glass
- Proflame I GT remote control (U31)
- Proflame I GTM remote control (E21)
- Log set with glowing embers
- Flame height adjustment control
- Variable speed blower
- Standing pilot system
- Direct spark ignition
- B vent
- Installation spacer
- Limited lifetime warranty

OPTIONS

- Low profile faceplates
- Custom backing plate
- Contour faceplate (U31)
- Hearth trim kit (U31)
- Black louvers (U31)
- Brick panels
- Basic or programmable wall thermostat
- 4" to 3" flue collar (E21)
- Regency flex liners
- Propane conversion kit



L234 shown with Low Profile faceplate and Brick panels.

REGENCY LIBERTY®

L234 Small Gas Insert

COMPACT SIZE FOR TIGHTER OPENINGS

Designed to fit smaller openings in existing masonry fireplaces and inefficient steel fireplaces, this small gas insert delivers efficient heat with stylish good looks. Highly realistic logs make this quality, small gas insert an excellent choice for small to medium size spaces.

SPECIFICATIONS (NATURAL GAS)*

Input (BTU)	23,500
Turn down to (BTU)	12,500
Efficiency (steady state)	73.94%
EnerGuide Rating (Canada only)	63.34%

MINIMUM FIREPLACE OPENING

Width (front)	25"
Width (rear)	16"
Height	17"
Depth (without spacer)	14"

*For propane (LP) specs please see page 28.



L234 shown with Low Profile faceplate and Brick panels.

FEATURES

- Natural gas
- Safety screen
- Ceramic safety glass
- Proflame I GTM remote control
- Log set with glowing embers
- 30° angled flue for versatile installation
- Variable speed blower
- Installation spacer
- Flame height adjustment control
- Standing pilot system
- Direct spark ignition
- Direct vent
- Limited lifetime warranty

OPTIONS

- Low profile faceplate
- Custom backing plate
- Adjustable hearth riser
- Brick panels
- Basic or programmable thermostat
- 3" to 2" air intake reducer
- Regency flex liners
- Propane conversion kit

BACKING PLATES, FACEPLATES & INLAYS

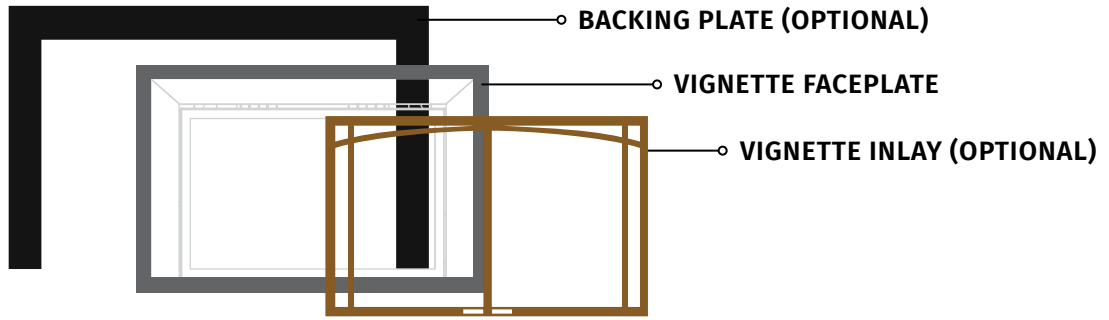

BACKING PLATE OPTIONS*



Small Backing Plate

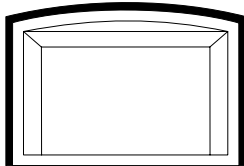

Arched Backing Plate

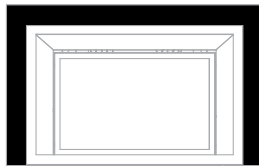

Regular Backing Plate

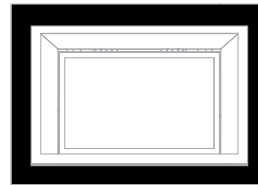

4-sided Regular Backing Plate

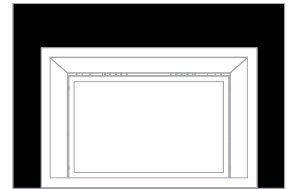

Oversized Backing Plate

*Custom sizes also available

VIGNETTE FACEPLATE OPTIONS



Vignette Faceplate

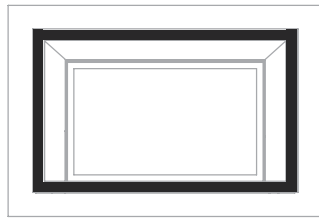

Vignette Faceplate (4-sided)

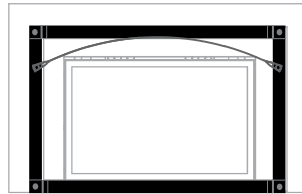

Georgian Rustic Vignette Faceplate

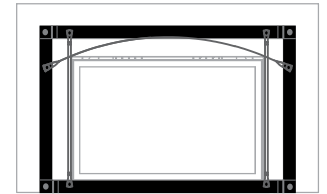

Tudor Rustic Vignette Faceplate

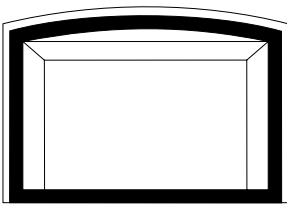

Arched Vignette Faceplate

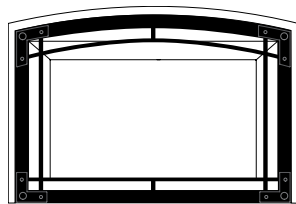

Decorative Arched Vignette Faceplate

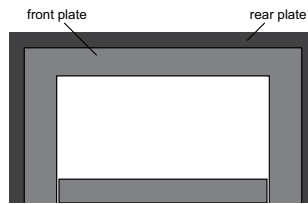

Low Profile Faceplate

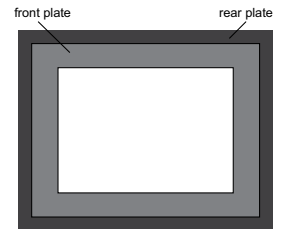

Low Profile Faceplate (4-sided)

VIGNETTE INLAY OPTIONS



Vignette Door Inlay**

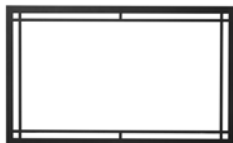

Vignette Craftsman Inlay**

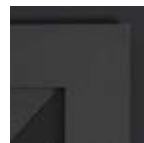

Black



Black Chrome



Tuscan Sunset



Platinum
(Not available
for inlays)



Iron Grey
(Only available for
Georgian & Tudor
Vignette Faceplates)

VIGNETTE FACEPLATE & VIGNETTE INLAY FINISHES

**LR13E/HRI3E Inlay designs are not exactly as shown

OPTIONS

FACEPLATE OPTIONS

Vignette faceplate shown with regular backing plate



Vignette faceplate shown with 4-sided regular backing plate



Georgian rustic Vignette faceplate



Tudor rustic Vignette faceplate



Arched Vignette faceplate



INLAY OPTIONS

Vignette door inlay



Vignette craftsman inlay



FINISHING OPTIONS

CRYSTALS & FIREBEADS



Crystals - Black

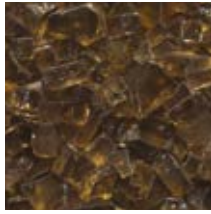

Crystals - Copper



Crystals - Starfire



Firebeads - Black

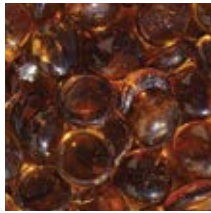

Firebeads - Caramel Luster



Firebeads - Glacier Ice

STONES & LOGS



Volcanic Stones - Gray



Volcanic Stones - Tan



Ceramic Spa Stones



Natural River Pebbles



Driftwood Ceramic Log Set

INNER PANELS



Reflective Black Enamel Panels



Standard - Rustic Brown



Standard - Old Town Red



Standard - Volcanic Black

ACCESSORIES

ACCESSORIES - AT A GLANCE			LRI3E	HRI3E	LRI4E	HRI4E	LRI6E	HRI6E	E33	U31	L234	E21	
Horizon firebed	Crystals in various colors		•	★	•	★	•	★	•	•	•	•	
	Firebeads in various colors		•	★	•	★	•	★	•	•	•	•	
	Ceramic spa stones		•	★	•	★	•	★	•	•	•	•	
	Volcanic stones		•	★	•	★	•	★	•	•	•	•	
	Driftwood log set (natural gas only on HRI4E & HRI6E)		•	★	•	★	•	★	•	•	•	•	
Backing plates	Small		★	★	★	★	★	★	•	•	•	•	
	Regular		★	★	★	★	★	★	•	•	•	•	
	4-sided regular		★	★	★	★	★	★	•	•	•	•	
	Oversized		★	★	★	★	★	★	•	•	•	•	
	Arched		★	★	★	★	★	★	•	•	•	•	
Vignette faceplates	Vignette	Black	★	★	★	★	★	★	•	•	•	•	
		Black chrome	★	★	★	★	★	★	•	•	•	•	
		Platinum	★	★	★	★	★	★	•	•	•	•	
		Tuscan sunset	★	★	★	★	★	★	•	•	•	•	
	Vignette – 4-sided		Black	•	•	•	•	•	•	★	•	•	•
	Rustic Vignette	Georgian	Black	★	★	★	★	★	★	•	•	•	•
			Iron grey	★	★	★	★	★	★	•	•	•	•
		Tudor	Black	★	★	★	★	★	★	•	•	•	•
			Iron grey	★	★	★	★	★	★	•	•	•	•
	Arched Vignette	Arched	Black	★	★	★	★	★	★	•	•	•	•
Decorative Arched		Black	★	★	★	★	★	★	•	•	•	•	
Vignette inlays	Door inlay	Black	★	★	★	★	★	★	★	•	•	•	
		Black chrome	★	★	★	★	★	★	★	•	•	•	
		Tuscan sunset	★	★	★	★	★	★	★	•	•	•	
	Craftsman inlay	Black	★	★	★	★	★	★	•	•	•	•	
		Black chrome	★	★	★	★	★	★	•	•	•	•	
		Tuscan sunset	★	★	★	★	★	★	•	•	•	•	
Low profile faceplates	Low profile – 3-sided	Black	•	•	•	•	•	•	★	★	★	★	
	Low profile – 3-sided – oversize	Black	•	•	•	•	•	•	★	•	•	•	
	Low profile – 3-sided – custom	Black	•	•	•	•	•	•	★	★	★	★	
Contour faceplate	Black	•	•	•	•	•	•	•	★	•	•		
Louvers	Black	•	•	•	•	•	•	•	★	•	•		
Inner panels	Bricks	Rustic brown	★	•	★	•	★	•	★	★	★	★	
		Old town red	★	•	★	•	★	•	★	★	★	★	
		Volcanic black	★	•	★	•	★	•	•	•	•	•	
	Steel	Black	•	✓	★	★	✓	✓	✓	✓	✓	✓	
	Reflective	Black enamel	★	★	★	★	★	★	•	•	•	•	
Safety screen		✓	✓	✓	✓	✓	✓	✓	✓	✓	✓		
Spacer		•	•	★	★	★	★	★	-	•	•		
Hearth trim		★	★	★	★	★	★	★	★	★	•		
Variable speed blower		✓	✓	✓	✓	✓	✓	✓	✓	✓	✓		
Wall thermostat		★	★	★	★	★	★	★	★	★	★		
Remote control	Proflame GT	•	•	•	•	•	•	•	•	✓	•	•	
	Proflame GTM	•	•	•	•	•	•	•	✓	•	✓	✓	
	Proflame GTMF	✓	✓	✓	✓	✓	✓	✓	•	•	•	•	
Turn down flame modulator		✓	✓	✓	✓	✓	✓	✓	✓	✓	✓		
Direct vent		✓	✓	✓	✓	✓	✓	✓	•	✓	-		
B-Vent		•	•	•	•	•	•	•	✓	•	✓		
Intelligent Ignition system		✓	✓	✓	✓	✓	✓	•	•	•	•		
Propane conversion kit		★	★	★	★	★	★	★	★	★	★		

- Not available
- ✓ Standard
- ★ Optional

NOTE: All product specifications are subject to change without notice. Before installing refer to the relevant product manual for full and up to date information.

MAXIMIZING COMFORT AND EFFICIENCY

Regency Fireplace Inserts deliver **controllable heat solutions** that combine the latest in radiant and convection heat technology with innovative features:

- ☑ Adjustable flame/heat control with Proflame remote controls.
- ☑ Heat radiating ceramic glass for maximum radiant heat.
- ☑ Safety screen.
- ☑ Variable speed blower to distribute heat into the farthest corners of your room.
- ☑ Intelligent Ignition System features fuel saving intermittent pilot ignition (IPI), 7-day continuous pilot mode (CPI), and 5 second Flame Failure Response Time (FFRT) for more reliable startups - even in cold weather.
- ☑ Power's Out, Heat's On. Never worry about being cold during a power outage again! All Regency gas fireplaces operate without electricity. Enjoy peace of mind all winter long.

REMOTE CONTROL - INCLUDED



Proflame I GTMF Remote Control



Proflame II GTMF Remote Control

Create optimal comfort with ease and convenience at the touch of a button with a Regency remote control. Our **user friendly programmable controls** can be set, adjusted and programmed for your fireplace to turn on at the temperature you want, when you want it.

FEATURE	DESCRIPTION	PROFLAME REMOTES		
		GT	GTM	GTMF
On/off		✓	✓	✓
Child lock		✓	✓	✓
LCD backlit screen		✓	✓	✓
Temperature display	°F / °C	✓	✓	✓
Thermostat	one setting (all days)	✓	✓	✓
Smart thermostat*		✓	✓	✓
Flame adjustment	(6 levels)	·	✓	✓
Fan control	(6 levels)	·	·	✓

- Not available
- ✓ Standard

*Smart Thermostat - Rather than a thermostat that simply turns your fireplace on and off, the smart control function allows you to set your desired room temperature. As the room reaches your personal setting, the flame intensity and heat will gradually decrease - keeping the ambiance of your Regency fire on with less heat output, and the option to turn it off at any time.

SAFETY SCREEN - INCLUDED

Regency has integrated a custom designed safety screen into each faceplate design that meets or exceeds current North American safety legislation.

*Low profile faceplate shown

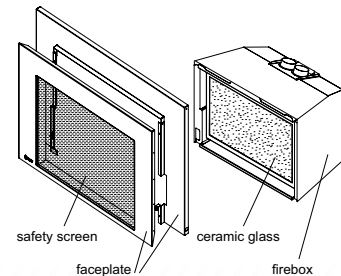

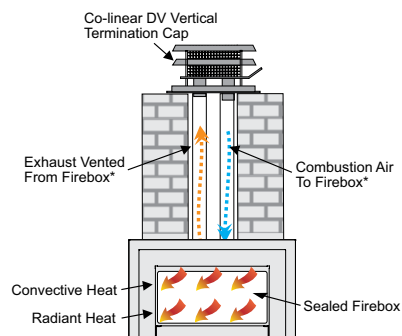

*May be reversed on certain models.

DIRECT VENT TECHNOLOGY

A Regency gas insert is a specially engineered, sealed fireplace that slips into your existing masonry or pre-fab fireplace to create a **high efficiency heating system** with a beautiful fire. The airtight firebox uses outside air for combustion helping maintain indoor air quality and keeping all the warmth generated from your fireplace in your home.

Even when the fireplace is turned off, the sealed system will prevent cold air from entering the home and warm air from leaving.

INTELLIGENT IGNITION SYSTEM

The Intelligent Ignition System included in Regency gas fireplace inserts helps save you money while maintaining fireplace reliability and performance. It does this by ensuring the pilot light is lit only when it is needed. With **intermittent pilot ignition (IPI)** the pilot light is lit only before the fireplace is used.

For colder climates the fireplace can also be set to **continuous pilot mode (CPI)** where the pilot will stay lit for up to 7 full days between uses. With a new **5 second Flame Failure Response Time (FFRT)** sensor, the ability to light the pilot light the first time is improved drastically, especially in cold climates. Experience increased reliability, performance and lower gas bills with the intelligent ignition system from Regency.

SPREAD THE WARMTH

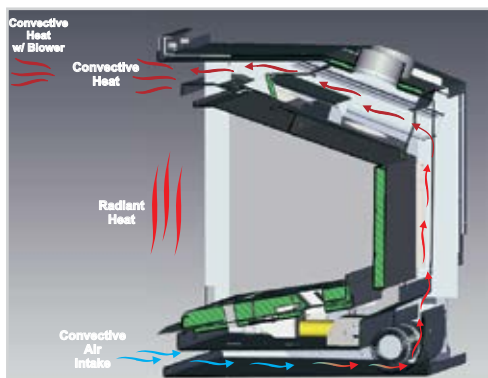

Blower

REMARKABLE EFFICIENCY

The precision engineered heat exchanger systems dramatically increase the overall heating efficiency of these Regency gas inserts. The cold air from your room passes through the pre-heated heat exchanger system which is then re-distributed back into your room as comforting warm air (also known as **convection heat**).

POWERFUL RADIANT HEAT

Not only do these gas inserts include the latest innovations in fireplace technology and efficiencies, they also generate a large amount of **radiant heat** from the flames and glow of the fire package. The heat from the fire radiates through the ceramic glass and transfers that warmth to you, providing the perfect combination of radiant and convective heat distribution.

VARIABLE SPEED BLOWER TO MAXIMIZE EFFICIENCY

Regency blowers are a standard feature with all gas inserts. A blower will let you enjoy the warmth of your fireplace from any corner of your living space. Our **quiet blowers** increase the efficiency of your fireplace by pushing the heat produced by your fireplace forward, distributing it further and evenly into your room.

SPECIFICATIONS & DIMENSIONS

SPECIFICATIONS (PROPANE)

SPECIFICATIONS (PROPANE)	HRI6E	LRI6E	HRI4E	LRI4E	HRI3E	LRI3E	E33	U31	E21	L234
Input (BTU)	38,000	38,000	31,000	31,000	19,000	19,000	35,500	28,000	22,500	21,500
Turn Down To (BTU)	30,000	30,000	26,000	26,000	15,500	15,500	19,000	22,000	11,250	11,000
Efficiency (Steady State)	73.01%	73.01%	73.01%	73.01%	72.87%	74.59%	70.73%	59.29%	64.65%	74.67%
EnerGuide Rating (Canada Only)	70.37%	70.37%	69.36%	69.36%	66.24%	66.70%	61.49%	47.41%	52.88%	64.73%

DIMENSIONS

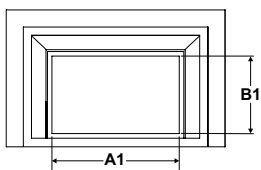

FRONT VIEW

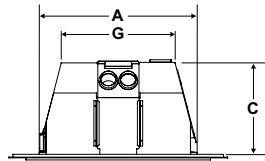

TOP VIEW

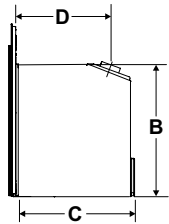

SIDE VIEW

HRI6E, LRI6E, HRI4E,
LRI4E, HRI3E, LRI3E,
E33, L234

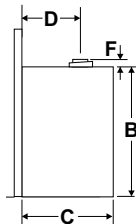

SIDE VIEW

U31, E21

	A	B	A1	B1	C	D	F	G
HRI6E	33-15/16"	23-5/8"	28-3/16"	18-5/16"	19-3/8"	14-11/16"	-	24-1/2"
LRI6E	33-15/16"	23-5/8"	28-3/16"	18-5/16"	19-3/8"	14-11/16"	-	24-1/2"
HRI4E	30"	20"	24-3/16"	14-3/4"	17-7/8"	14-5/16"	-	21-11/16"
LRI4E	30"	20"	24-3/16"	14-3/4"	17-7/8"	14-5/16"	-	21-11/16"
HRI3E	28"	19"	22-11/16"	14-1/4"	14"	10-3/8"	-	21-1/4"
LRI3E	28"	19"	22-11/16"	14-1/4"	14"	10-3/8"	-	21-1/4"
E33	32-1/4"	23-3/4"	30-3/8"	14-3/4"	16-1/4"	11-1/16"	-	24-1/2"
U31	26-1/16"	20-1/4"	24-1/2"	13"	13-1/2"	11"	11/16"	22-1/2"
E21	28-3/16"	17-1/2"	24-7/8"	9-11/16"	14-1/4"	11-1/2"	1"	17-1/2"
L234	24-3/4"	16-7/8"	17-3/4"	12-1/2"	14-11/16"	11-3/4"	-	14-3/4"

BACKING PLATE DIMENSIONS

BACKING PLATE	HRI6E		LRI6E		HRI4E		LRI4E		HRI3E		LRI3E	
	WIDTH	HEIGHT	WIDTH	HEIGHT	WIDTH	HEIGHT	WIDTH	HEIGHT	WIDTH	HEIGHT	WIDTH	HEIGHT
Small	41"	27-3/4"	41"	27-3/4"	37-1/8"	23-7/8"	37-1/8"	23-7/8"	31-1/4"	23-3/8"	31-1/4"	23-3/8"
Regular (3-sided)	47-3/8"	30-1/2"	47-3/8"	30-1/2"	41-5/8"	26"	41-5/8"	26"	35-3/4"	25-5/8"	35-3/4"	25-5/8"
Regular (4-sided)	47-3/8"	34-1/8"	47-3/8"	34-1/8"	41-5/8"	29-1/4"	41-5/8"	29-1/4"	35-3/4"	28-5/8"	35-3/4"	28-5/8"
Oversized	48-3/8"	33"	48-3/8"	33"	44"	30"	44"	30"	38-3/16"	29-5/8"	38-3/16"	29-5/8"
Custom Backing Plate	Custom Order Only											

BACKING PLATE	HRI6E/LRI6E			HRI4E/LRI4E			HRI3E/LRI3E		
	WIDTH	CENTRE HEIGHT	CORNER HEIGHT	WIDTH	CENTRE HEIGHT	CORNER HEIGHT	WIDTH	CENTRE HEIGHT	CORNER HEIGHT
Arched	50-7/8"	33-1/16"	29-13/16"	45-7/8"	28-15/16"	25-15/16"	40-15/16"	27-11/16"	24-1/2"

SPECIFICATIONS

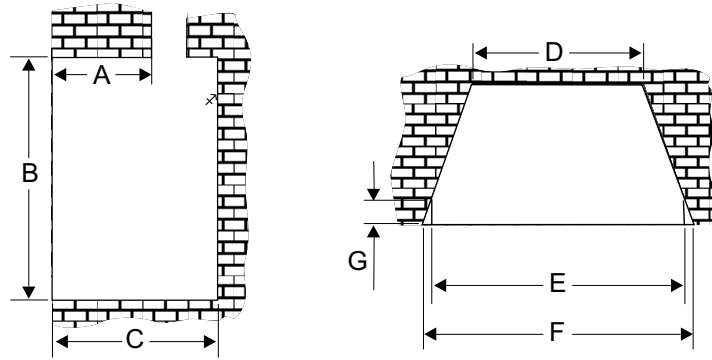

MINIMUM FIREPLACE OPENINGS		A	B	C	D	E	F	G
HRI6E	Vignette Faceplate	12-1/2"	24"	19-1/2"	25"	34"	37"	4-3/4"
	Vignette Faceplate + Spacer	10"	24"	16-3/4"	25"	34"	35-3/8"	2-1/4"
	Arched Vignette Faceplate	13-1/2"	25-3/4"	22-3/8"	25"	35-3/4"	37"	6"
	Arched Vignette Faceplate + Spacer	12"	24"	19-1/2"	25"	34"	36-1/4"	4-3/4"
LRI6E	Vignette Faceplate	12-1/2"	24"	19-1/2"	25"	34"	37"	4-3/4"
	Vignette Faceplate + Spacer	10"	24"	16-3/4"	25"	34"	35-3/8"	2-1/4"
	Arched Vignette Faceplate	13-1/2"	25-3/4"	22-3/8"	25"	35-3/4"	37"	6"
	Arched Vignette Faceplate + Spacer	12"	24"	19-1/2"	25"	34"	36-1/4"	4-3/4"
HRI4E	Vignette Faceplate	12-1/4"	20"	18"	22"	30"	35-5/8"	4-3/8"
	Vignette Faceplate + Spacer	10"	20"	15-3/4"	22"	30"	31-1/4"	2-1/8"
	Arched Vignette Faceplate	14"	21-1/2"	21-1/8"	22"	30-1/2"	37"	5-3/8"
	Arched Vignette Faceplate + Spacer	12-1/2"	20"	17-1/2"	22"	30"	36-1/4"	4"
LRI4E	Vignette Faceplate	12-1/4"	20"	18"	22"	30"	35-5/8"	4-3/8"
	Vignette Faceplate + Spacer	10"	20"	15-3/4"	22"	30"	31-1/4"	2-1/8"
	Arched Vignette Faceplate	14"	21-1/2"	21-1/8"	22"	30-1/2"	37"	5-3/8"
	Arched Vignette Faceplate + Spacer	12-1/2"	20"	17-1/2"	22"	30"	36-1/4"	4"
HRI3E	Vignette Faceplate	8-5/8"	19-1/2"	14-1/2"	21-5/8"	28-1/2"	31-1/8"	4"
	Arched Vignette Faceplate	8-5/8"	19-1/2"	14-1/2"	21-5/8"	28-5/8"	31-1/8"	4"
LRI3E	Vignette Faceplate	8-5/8"	19-1/2"	14-1/2"	21-5/8"	28-1/2"	31-1/8"	4"
	Arched Vignette Faceplate	8-5/8"	19-1/2"	14-1/2"	21-5/8"	28-5/8"	31-1/8"	4"
E33	Low Profile Faceplate	9-1/4"	25-1/2"	18"	25"	32-1/4"	32-1/4"	N/A
	Low Profile Faceplate + Spacer	8"	24-3/16"	16-3/4"	25"	32-1/4"	32-1/4"	N/A
U31	Low Profile Faceplate	8-1/8"	21"	15"	22-1/2"	26-1/2"	26-1/2"	N/A
E21	Low Profile Faceplate	11-1/2"	18-5/8"	14-3/8"	18"	28-3/8"	28-3/4"	3/4"
	Low Profile Faceplate + Spacer	10-1/8"	17-3/4"	13-1/8"	18"	N/A	26-1/2"	N/A
L234	Low Profile Faceplate	N/A	17"	14" (with spacer) 15-5/8" (without spacer)	16"	25"	25"	N/A

A - Max. lintel bar depth
G - Front depth prior to taper

NOTE: All product specifications are subject to change without notice. Before installing refer to the relevant product manual for full and up-to-date information.

SPECIFICATIONS

FACEPLATES	HRI6E		LRI6E		HRI4E		LRI4E		HRI3E		LRI3E	
	WIDTH	HEIGHT	WIDTH	HEIGHT	WIDTH	HEIGHT	WIDTH	HEIGHT	WIDTH	HEIGHT	WIDTH	HEIGHT
Vignette and Rustic Vignette	40-1/16"	26-13/16"	40-1/16"	26-13/16"	35-1/16"	22-11/16"	35-1/16"	22-11/16"	29-1/4"	22-1/8"	29-1/4"	22-1/8"
Vignette Spacer	39-15/16"	26-3/4"	39-15/16"	26-3/4"	34-15/16"	22-5/8"	34-15/16"	22-5/8"	--	--	--	--
Hearth Trim - Sizes	Please See Manual For Details											

FACEPLATES	HRI6E/LRI6E			HRI4E/LRI4E			HRI3E/LRI3E		
	WIDTH	CENTRE HEIGHT	CORNER HEIGHT	WIDTH	CENTRE HEIGHT	CORNER HEIGHT	WIDTH	CENTRE HEIGHT	CORNER HEIGHT
Arched Vignette	45-3/8"	30-7/16"	27-13/16"	40-1/4"	26-1/8"	23-3/4"	35-15/16"	25-3/16"	22-3/4"
Spacer	45-3/8"	30-7/16"	27-13/16"	40-1/4"	26-1/8"	23-3/4"	--	--	--

FACEPLATES	E33		U31		E21		L234		
	WIDTH	HEIGHT	WIDTH	HEIGHT	WIDTH	HEIGHT	WIDTH	HEIGHT	
Vignette (3-Sided)	46-1/2"	28-3/4"	--	--	--	--	--	--	
Vignette (4-Sided)	46-1/2"	30-7/8"	--	--	--	--	--	--	
Custom Faceplate (3-Sided Vignette Only)	Custom Order Only		--	--	--	--	--	--	
Spacer (3-Sided Vignette Only)	45"	28"	--	--	--	--	--	--	
Low Profile (3-Sided)	Front Plate	42-7/16"	26-3/4"	36"	22-1/8"	36"	20-1/4"	29-1/8"	21"
	Rear Plate	46-1/2"	28-11/16"	40-13/16"	24"	40-3/16"	22-7/8"	32-7/8"	22-7/8"
Low Profile (3-Sided Oversize)	Front Plate	42-7/16"	26-3/4"	--	--	36"	20-1/4"	--	--
	Rear Plate	49-9/16"	33-1/8"	--	--	44-1/8"	24-3/4"	--	--
Low Profile (3-Sided) Custom	Rear Plate	Custom Order Only							
Low Profile (4-Sided) Custom	Rear Plate	Custom Order Only							
Hearth Trim - Sizes	Please See Manual For Details								

MINIMUM CLEARANCE TO COMBUSTIBLES		HRI6E	LRI6E	HRI4E	LRI4E	HRI3E	LRI3E	E33	U31	E21	L234
A	Side Wall	12"	12"	6"	6"	6"	6"	8"	10"	9"	8"
B	Ceiling	60"	60"	60"	60"	60"	60"	72"	66-1/2"	53-1/2"	73"
C	Mantel Height (Min.)	40"	40"	35"	35"	38"	38"	40"	32-1/2"	31-1/2"	38"
	(With Optional Deflector)	36"	36"	32"	32"	28"	28"	N/A	N/A	N/A	N/A
D	Mantel Depth (Min.)	1"	1"	1"	1"	1"	1"	0 - 3-1/2"	0 - 3-1/2"	0 - 3-1/2"	1"
	(With Optional Deflector)	1"	1"	1"	1"	1"	1"	N/A	N/A	N/A	N/A
E	Alcove Width	56"	56"	54"	54"	54"	54"	76"	48"	48"	60"
F	Max. Alcove Depth	36"	36"	36"	36"	36"	36"	36"	36"	36"	36"

NON-COMBUSTIBLE HEARTH REQUIREMENT											
G	Hearth Height	1-3/8"	1-3/8"	1/2"	1/2"	1/2"	1/2"	1-1/4"	0"	0"	1-1/2"
H	Hearth Width	44"	44"	40"	40"	36"	36"	45-1/2"	0"	0"	28"
I	Hearth Depth	14"	14"	14"	14"	12"	12"	13"	0"	0"	12"

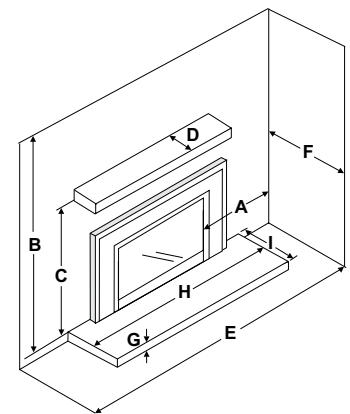

FIREPLACE SELECTION WORKSHEET

We want you to enjoy your beautiful Regency fireplace for years to come. To help you figure out which product is just right for your home, fill in the following worksheet. Once complete, visit your nearest Regency dealer. Your professional Regency dealer will assess your needs - including local building codes - and install your Regency.

1. BASIC PRODUCT FUNCTION QUESTIONS

- a. I would like my unit to provide me with: Supplemental heating Priority heating
- b. The room/rooms I would like to heat are: _____ sq. ft.

2. FIREPLACE PRODUCT TYPE AND MEASUREMENTS

- a. I am: Installing a new fireplace Installing into an existing fireplace
- b. Fill in the following measurements:
 Ceiling Height: _____
 Location in the room: _____
- c. What is the:
 Flooring material: _____
 Wall material: _____
 Ceiling material: _____
- d. Fireplace opening dimensions:
 Width (front): _____
 Width (back): _____
 Height: _____
 Depth: _____

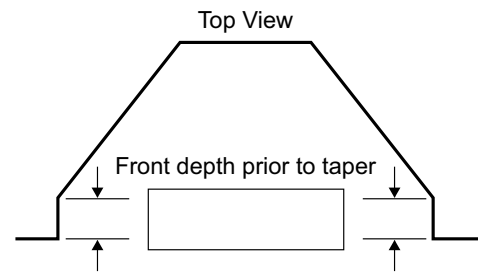
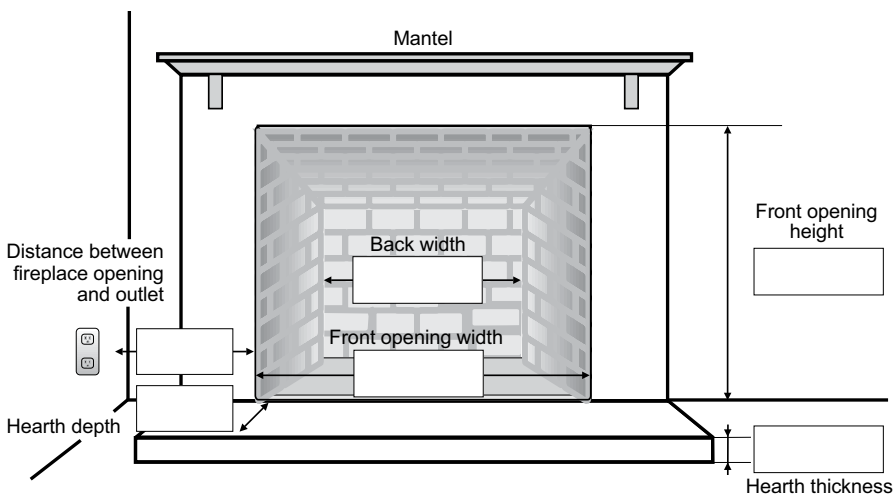
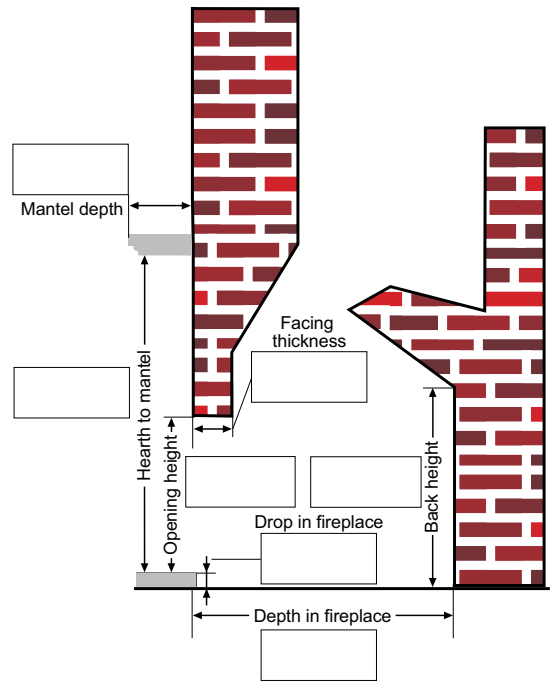

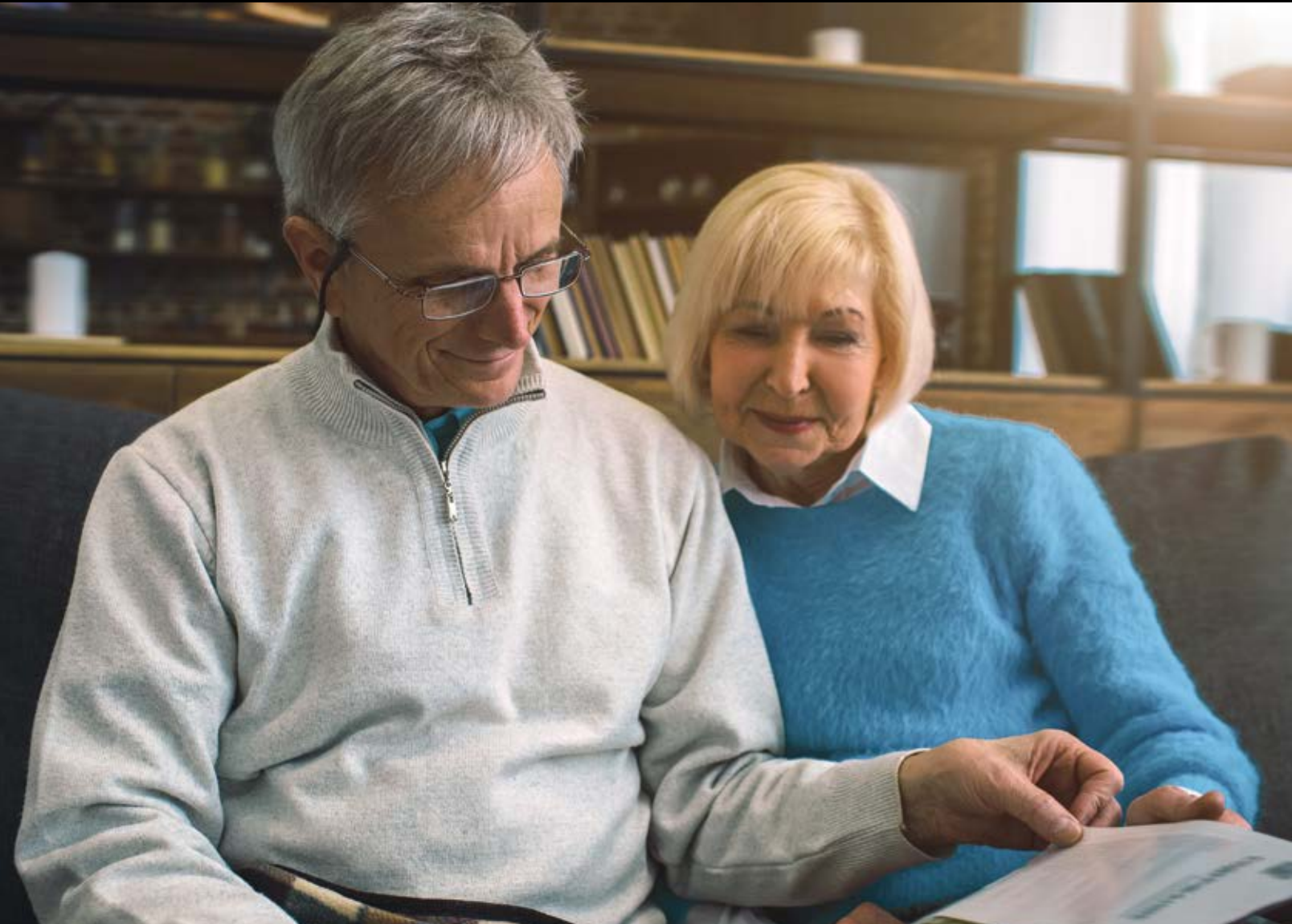

regency-fire.com

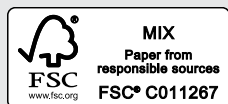
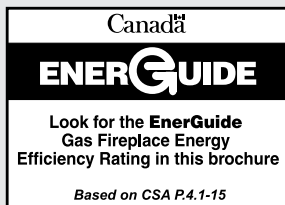

©2019 FPI Fireplace Products International Ltd. Regency®, Regency Liberty®, Regency Horizon®, Regency Energy™ and Surefire™ are registered or proprietary trademarks of FPI Fireplace Products International Ltd. All rights reserved. Printed in Canada (07/19) Part no. 944-072

Your Regency Dealer